



Specifications

M-5 Meter

Liquid Controls M and MA Series rotary motion positive displacement (PD) meters offer the ultimate in measurement accuracy for custody transfer of petroleum products, aviation fuels, LPG and a broad of industrial liquids.

Superior performance features

Low pressure drop – will operate on gravity flow or pump pressure.

Sustained accuracy – no metal-to-metal contact inside the measuring chamber means minimal wear and deterioration in accuracy over time, fewer recalibrations and a longer service life. Meters conform to NIST and International Weight and Measures accuracy requirements.

Wide viscosity range – LCE meters can accurately meter products from less than 30 SSU (1 cP) to 1500000 SSU (325000 cP).

Maximum adaptability - choice of stock or custom elbows/fittings provides unequalled mounting flexibility to meet widely varying installation requirements.

Industries served

LC series M and MA meters are well-suited for use in industries requiring precise flow measurement and reliable, extended service life:

- Refined petroleum products
- Aviation fuels
- LPG
- Agricultural chemicals
- Paints and coatings
- Foods and beverages
- Petrochemicals
- Pharmaceuticals
- Cosmetics
- Printing inks
- Textiles

Accuracy/Performance

Repeatability

Mechanical registration: capable of 0.05% of reading over entire range
Electronic registration: capable of 0.03% of reading over entire range

Linearity

Over 5:1 range

Mech. registration: capable of $\pm 0.125\%$ or better from max. nom. flow rate
Elect. registration: capable of $\pm 0.10\%$ or better from max. nom. flow rate

Over 10:1 range

Mech. registration: capable of $\pm 0.22\%$ or better from max. nom. flow rate
Elect. registration: capable of $\pm 0.10\%$ or better from max. nom. flow rate

Over 40:1 range

Mech. registration: capable of $\pm 0.5\%$ or better from max. nom. flow rate
Elect. registration: capable of $\pm 0.15\%$ or better from max. nom. flow rate

Temperature range

-40° F to 160° F (-40° C to 71° C)

Construction

Meter housing and rotors
Cast aluminum (other metallurgies, available including brass, cast-iron and stainless steel)

Internal components
Aluminum, Ni-Resist, stainless steel

Seal material
UL recognize component:
Buna-N, Viton, Teflon

Bearings
Carbon, Teflon, Ni-Resist

Dimensions: flow meters with electronic registration

Note: Dimensions shown are not for construction use. Consult factory when certified engineering prints are required.

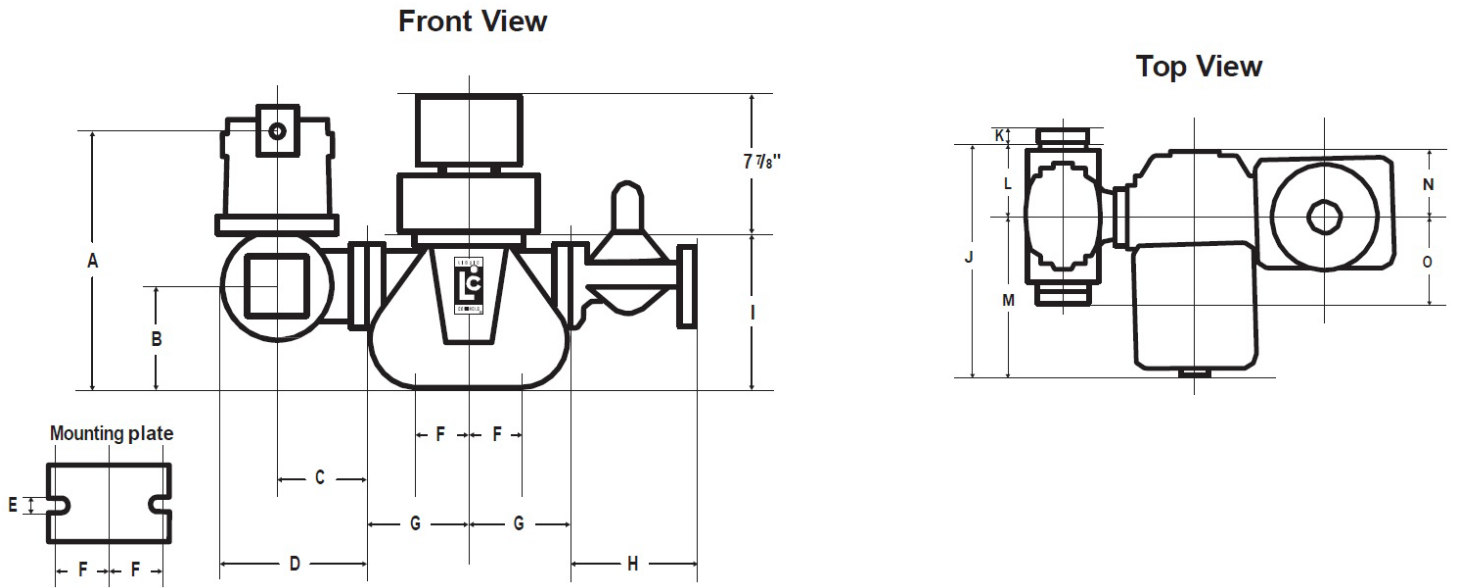

Model	Flange size	Max nom. Flow rate	Working pressure	Net weight	Dimensions						
					A	B	C	D	E	F	
M-5	1½" or 2"	250 l/min (66 GPM)	10,5 bar (150 PSI)	6,4 kg (14 lbs)	in	14.2	5.3	4.1	6.8	.56	1.9
					mm	360	135	105	172	14	48

Dimensions									
	G	H	I	J	K	L	M	N	O
in	4.9	8.3	8.6	13.9	.9	4.7	9.2	3.2	4.6
mm	125	213	219	352	24	119	233	81	116

Construction and application classes

LC series M and MA PD meters are suitable for metering a broad range of products as listed below. The appropriate meter class can be used to specify a desired meter by using the table on the next page of this publication.

Class	Description	Bearing Material
1	Refined petroleum products	Ni-Resist
2	Aviation and jet fuel	Ni-Resist
3	Variety of product includes: liquid sugars, sweeteners, syrups, vegetable oils	Ni-Resist
4	Treated waters and solvents where no red metals are allowed	Carbon
8	Acid pH liquids includes: nitric, phosphoric, glacial acetic acids, citric juices, vinegar	Carbon
14	Crude oil	Ni-Resist
16	General solvents	Carbon
30	Herbicides	Carbon



LIQUID CONTROLS EUROPE

Manufactured by SAMPI

A Unit of IDEX Corporation

S.A.M.P.I. spa - Via Amerigo Vespucci, 1

55011 Altopascio (Lucca) - ITALY

Phone: +39 0583 24751

Fax: +39 0583 264748