



# Specifications

## MS-30 Meter

Liquid Controls Europe MS Series rotary motion positive displacement (PD) meters offer the ultimate in measurement accuracy for custody transfer of petroleum products, aviation fuels, LPG and a broad of industrial liquids.

### Superior performance features

**Low pressure drop** – will operate on gravity flow or pump pressure.

**Sustained accuracy** – no metal-to-metal contact inside the measuring chamber means minimal wear and deterioration in accuracy over time, fewer recalibrations and a longer service life. Meters conform to NIST and International Weight and Measures accuracy requirements.

**Wide viscosity range** – LCE meters can accurately meter products from less than 30 SSU (1 cP) to 1500000 SSU (325000 cP).

**Maximum adaptability** - choice of stock or custom elbows/fittings provides unequalled mounting flexibility to meet widely varying installation requirements.

### Industries served

LCE series SM meters are well-suited for use in industries requiring precise flow measurement and reliable, extended service life:

- Refined petroleum products
- Aviation fuels
- LPG
- Agricultural chemicals
- Paints and coatings
- Foods and beverages
- Petrochemicals
- Pharmaceuticals
- Cosmetics
- Printing inks
- Textiles

### Accuracy/Performance

#### Repeatability

Mechanical registration: capable of 0.05% of reading over entire range  
Electronic registration: capable of 0.03% of reading over entire range

#### Linearity

##### Over 5:1 range

Mech. registration: capable of  $\pm 0.125\%$  or better from max. nom. flow rate  
Elect. registration: capable of  $\pm 0.10\%$  or better from max. nom. flow rate

##### Over 10:1 range

Mech. registration: capable of  $\pm 0.22\%$  or better from max. nom. flow rate  
Elect. registration: capable of  $\pm 0.10\%$  or better from max. nom. flow rate

##### Over 40:1 range

Mech. registration: capable of  $\pm 0.5\%$  or better from max. nom. flow rate  
Elect. registration: capable of  $\pm 0.15\%$  or better from max. nom. flow rate

#### Temperature range

-40° F to 160° F (-40° C to 71° C)

### Construction

Meter housing and rotors  
Cast aluminium (other metallurgies, available including brass, cast-iron and stainless steel)

Internal components  
Aluminium, Ni-Resist, stainless steel

Seal materials  
UL recognize component:  
Buna-N, Viton, Teflon

Bearings  
Carbon, Teflon, Ni-Resist

## Dimensions: steel case flow meters

Note: Dimensions shown are not for construction use. Consult factory when certified engineering prints are required.

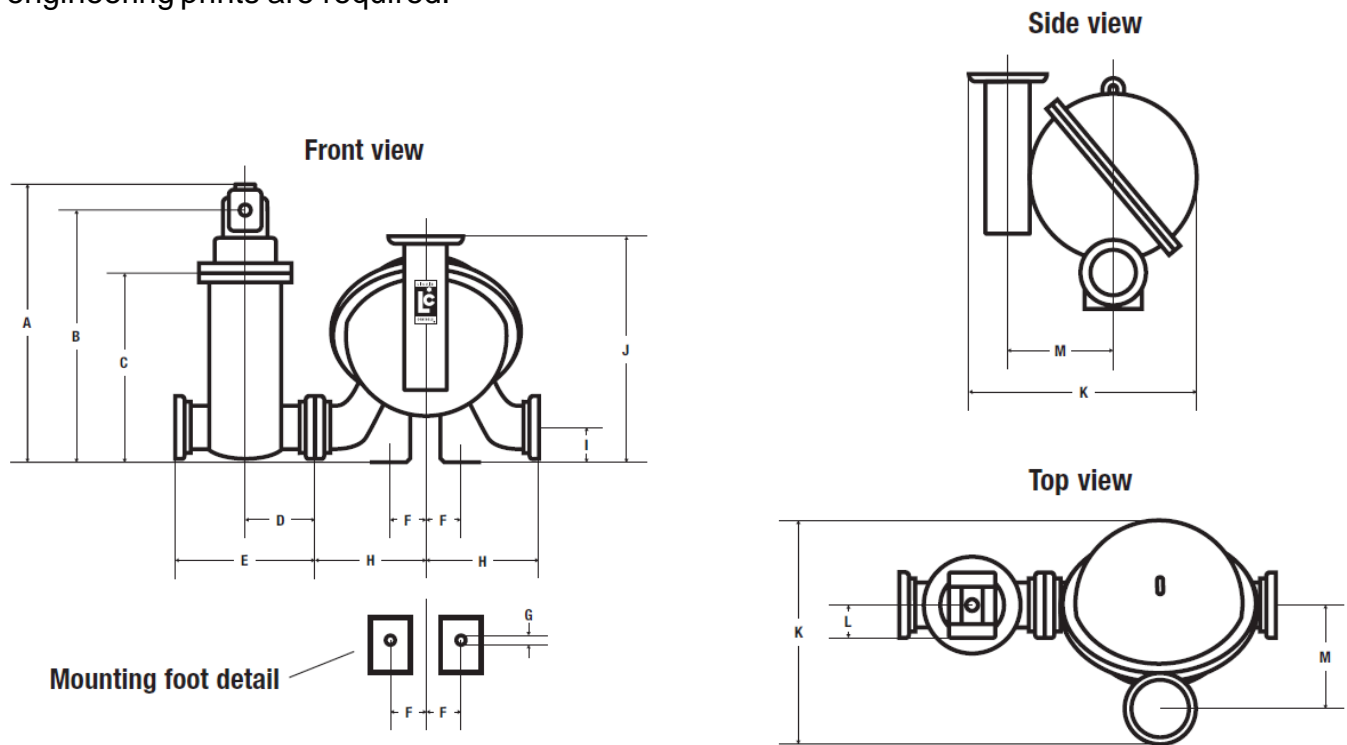

Model	Flange size	Max nom. Flow rate	Working pressure	Net weight	Dimensions	A	B	C	D
MS-30	3"	1325 l/min (350 GPM)	10,5 bar (150 PSI)	61,2 kg (135 lbs)	mm	706	635	470	178
					in	27.8	25	18.5	7
Dimensions	E	F	G	H	I	J	K	L	M
mm	356	89	19	279	107	688	561	34	254
in	14	3.5	.75	11	4.2	27.1	22.1	3.3	10

## Construction and application classes

LCE steel-case PD meters are suitable for metering a broad range of products as listed below. The appropriate meter class can be used to specify a desired meter by using the table on the next page of this publication.

Class	Description	Bearing Material
1	Refined petroleum products	Ni-Resist
2	Aviation and jet fuel	Ni-Resist
7	Chlorinated solvents	Carbon
8	Acid pH liquids includes: nitric, phosphoric, glacial acetic acids, citric juices, vinegar	Carbon
10	LPG	Carbon
14	Crude oil	Ni-Resist
16	General solvents	Carbon
37	Sodium Hydroxide solutions, high sulfur crude oil, alkaline pH liquids	Ni-Resist



**LIQUID CONTROLS EUROPE**

Manufactured by SAMPI

A Unit of IDEX Corporation

S.A.M.P.I. spa - Via Amerigo Vespucci, 1

55011 Altopascio (Lucca) - ITALY

Phone: +39 0583 24751

Fax: +39 0583 264748