



# Series MS

## Positive Displacement Flow Meters

### Overview

Liquid Controls Europe steel-case MS-series rotary motion positive displacement (PD) meters offer the ultimate in flow measurement accuracy for bulk custody transfer of petroleum products, aviation fuels, LPG, crude oil, petrochemicals and a broad range of industrial liquids. MS-series meters incorporate a unique design, presenting minimal intrusion in a flowing stream of liquid, as well as minimal pressure drop through the meter.

LCE MS-series meters consist of an outer spherical steel-case shell with flanged inlet and outlet ports. The shell houses a traditional LCE metering element that employs three rotating and synchronized rotors. These rotors accurately segment flow into a precise volume of liquid for each revolution, with no metal-to-metal contact inside the measuring chamber. Hydraulic sealing between the rotors and the measuring chamber wall is accomplished by a stationary boundary layer of liquid – not by the wiping action of mechanical parts – thereby ensuring sustained accuracy, long service life with minimal wear and low pressure drop suitable for operation on gravity flow or pump pressure.

All MS-series spherical shells are constructed of steel or stainless steel. Epoxy coated versions are available for aviation applications. Metering elements are available in metallurgies and seal materials suitable for a wide range of petroleum, petrochemical and industrial applications.

#### Accessories

MS-series meters are available with a selection of bolt-on strainers and air eliminators for inlet side and a selection of manual or solenoid actuated valves for the meter outlet. Mechanical and electronic registration equipment and printers are also available.

Contact factory for details.

#### Industries served

LCE series SM meters are well-suited for use in industries requiring precise flow measurement and reliable, extended service life:

- Refined petroleum products
- Aviation fuels
- LPG
- Agricultural chemicals
- Paints and coatings
- Foods and beverages
- Petrochemicals
- Pharmaceuticals
- Cosmetics
- Printing inks
- Textiles



Liquid Controls' unique measuring chamber with no metal-to-metal contact minimizes wear and ensures precise and consistent measurements over a long service life.

## Performance specifications

Liquid Controls Europe steel-case MS-Series positive displacement meters are engineered to provide accurate flow measurement and a long, trouble-free service life requiring minimal maintenance with few replacement parts. The unique construction of these meters results in low pressure drop for most liquids, delivering superior performance and minimal demand on system pumps. The exclusive LCE metering element eliminates inaccuracies due to clearance changes and maximizes life by minimizing loads on bearings and eliminating axial thrust. MS-Series meters' multiple inlet/outlet flange configurations (see mounting configurations diagram) provide unmatched mounting versatility and equal accuracy for forward or reverse flow.

LCE meters meet NTEP (NIST Handbook 44) and International Weights and Measures accuracy requirements as well as U.S. Military specifications.

### Accuracy/Performance<sup>a</sup>

#### Repeatability

Mech. registration: capable of ±0.05% of reading over entire range  
Elect. registration: capable of 0.03% of reading over entire range

#### Linearity

- Over 5:1 range  
Mech. registration: capable of ±0.125% or better from max. nom. flow rate  
Elect. registration: capable of ±0.10% or better from max. nom. flow rate
- Over 10:1 range  
Mech. registration: capable of ±0.22% or better from max. nom. flow rate  
Elect. registration: capable of ±0.10% or better from max. nom. flow rate
- Over 40:1 range  
Mech. registration: capable of ±0.5% or better from max. nom. flow rate  
Elect. registration: capable of ±0.15% or better from max. nom. flow rate

#### Temperature range

-40° F to 160° F (-40° C to 71° C)

<sup>a</sup> Stated accuracy obtainable when all variables remain constant. Reading/measurements reflect a minimum of one minute of flow at selected rate(s). All accuracy statements based on metering safety solvent (aliphatic hydrocarbon), approximate viscosity 1 CPS. On higher viscosity products, the average deviation in accuracy will be less.

### Construction

#### Meter housing

Steel or stainless steel (epoxy coated steel available for aviation and other applications)

#### Meter element and rotors

Cast aluminum (other metalurgies available including cast iron and stainless steel)

#### Internal components

Aluminum, Ni-Resist, stainless steel, iron

#### Seal materials

UL recognized component: Buna-N, Viton®, Teflon®

#### Bearings

Carbon, Teflon®, Ni-Resist, ceramic (MS-30 only)

Viton® and Teflon® are registered trademarks of DuPont Corporation.  
Victaulic® is a registered trademark of Victaulic Company.

MODEL	FLANGE SIZE	MAX NOM. FLOW RATE	WORKING PRESSURE	NET WEIGHT
MS7	2"	380 l/min 100 GPM	10.5 bar 150 PSI	43 kg 95 lbs
MSAA7	2"	380 l/min 100 GPM	19 bar 285 PSI	60,8 kg 134 lbs
MSA7	2"	380 l/min 100 GPM	21 bar 300 PSI	68,5 kg 151 lbs
MS15	3"	760 l/min 200 GPM	10.5 bar 150 PSI	50,4 kg 111 lbs
MSAA15	3"	760 l/min 200 GPM	19 bar 285 PSI	82,1 kg 181 lbs
MSA15	3"	760 l/min 200 GPM	21 bar 300 PSI	50,4 kg 111 lbs
MS30	3"	1325 l/min 350 GPM	10.5 bar 150 PSI	61,2 kg 135 lbs
MSAA30	3"	1325 l/min 350 GPM	19 bar 285 PSI	100 kg 220 lbs
MSA30	3"	1325 l/min 350 GPM	21 bar 300 PSI	61,2 kg 135 lbs
MS40	3"	1700 l/min 450 GPM	10.5 bar 150 PSI	61,2 kg 135 lbs
MS75	4"	2650 l/min 700 GPM	10.5 bar 150 PSI	174.6 kg 385 lbs
MSAA75	4"	2650 l/min 700 GPM	19 bar 285 PSI	174.6 kg 385 lbs
MSA75	4"	2650 l/min 700 GPM	21 bar 300 PSI	174.6 kg 385 lbs
MS120	6" or 8"	3785 l/min 1200 GPM	10.5 bar 150 PSI	222,3 kg 490 lbs
MSAA120	6" or 8"	3785 l/min 1200 GPM	19 bar 285 PSI	356 kg 785 lbs
MSA120	6" or 8"	3785 l/min 1200 GPM	21 bar 300 PSI	222,3 kg 490 lbs

## Dimensions: steel case flow meters

Note: Dimensions shown are not for construction use. Consult factory when certified engineering prints are required.

Additional inlet/outlet configurations available.

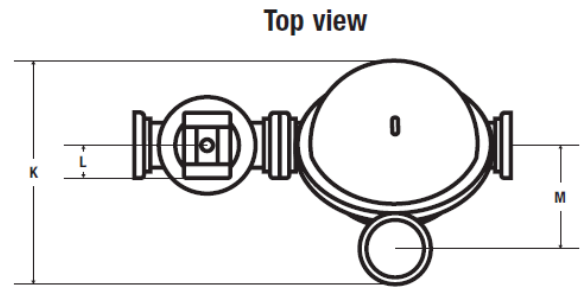
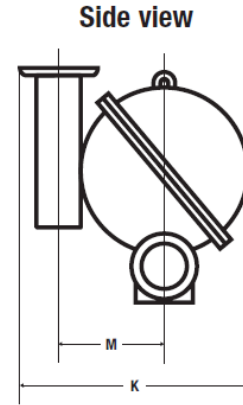
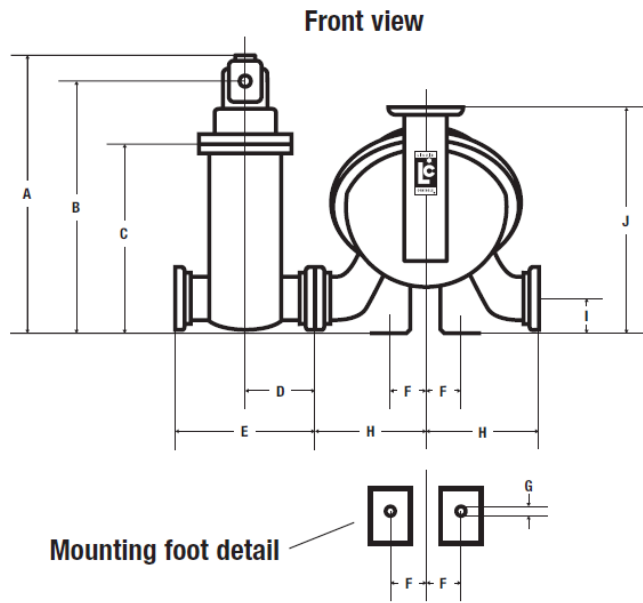

Dimensions	A	B	C	D	E	F	G	H	I	J <sup>c</sup>	K	L	M
in	26.9	24.1	17.6	7	14	3.5	.75	8.5	3.5	15.3	15.3	3.3	6.8
mm	683	612	447	178	356	89	19	216	89	389	389	84	173
in	26.9	24.1	17.6	7	14	3.5	.75	8.5	3.5	15.3	15.3	3.3	6.8
mm	683	612	447	178	356	89	19	216	89	389	389	84	173
in	25.9	23.1	16.6	7	14	3.5	.75	8.5	3.4	15.3	15.7	3.3	6.8
mm	658	587	422	178	356	89	19	216	89	389	398	84	173
in	27.8	24.9	18.5	7	14	3.5	.75	11	4.1	18	18.7	3.3	8.3
mm	706	632	470	178	356	89	19	279	104	457	475	34	211
in	27.8	24.9	18.5	7	14	3.5	.75	11	4.1	18	18.7	3.3	8.3
mm	706	632	470	178	356	89	19	279	104	457	475	34	211
in	26.7	23.9	17.4	7	14	3.5	.75	9.8	4.1	18	18.7	3.3	8.3
mm	678	607	442	178	356	89	19	249	104	457	475	34	211
in	27.8	25	18.5	7	14	3.5	.75	11	4.2	27.1	22.1	3.3	10
mm	706	635	470	178	356	89	19	279	107	688	561	34	254
in	27.8	25	18.5	7	14	3.5	.75	11	4.2	27.1	22.1	3.3	10
mm	706	635	470	178	356	89	19	279	107	688	561	34	254
in	26.7	23.9	17.4	7	14	3.5	.75	11.8	4.2	27.1	22.1	3.3	10
mm	678	607	442	178	356	89	19	300	107	688	561	34	254
in	27.8	25	18.5	7	14	3.5	.75	11	4.2	27.1	22.1	3.3	10
mm	706	635	470	178	356	89	19	279	107	688	561	34	254
in	30	27.2	20.7	7	14	5.3	.75	13.03	5.8	31.4	28.2	3.3	13.2
mm	762	691	526	178	356	135	19	331	147	798	716	34	335
in	30	27.2	20.7	7	14	5.3	.75	13.03	5.8	31.4	28.2	3.3	13.2
mm	762	691	526	178	356	135	19	331	147	798	716	34	335
in	28.3	25.5	19	7	14	5.3	.75	13.03	5.8	31.4	282	3.3	13.2
mm	719	648	483	178	356	135	19	331	147	798	716	34	335
in	36.5	33.7	27.1	10.5	21	6.5	1	17	7	34.9	31.6	3.3	14.7
mm	927	856	688	267	533	165	25	432	178	886	803	34	373
in	36.5	33.7	27.1	10.5	21	6.5	1	17	7	34.9	31.6	3.3	14.7
mm	927	856	688	267	533	165	25	432	178	886	803	34	373
in	32.8	30	23.4	10.5	21	6.6	1	17	7	34.9	31.6	3.3	14.5
mm	833	762	594	267	533	168	25	432	178	886	803	34	368

## Relationship of meter pressure drop to flow rate and viscosity

With LCE unique design, the bearing surfaces of the meter element are internally and externally subjected to the same system pressure. Due to the low pressure drop inherent to the LCE meter, it is often possible to satisfactorily meter higher viscosity products through a smaller LCE meter than its competitive equivalent.

Pressure drop through a meter depends on product temperature, viscosity and flow rate. When metering a liquid, the pressure drop will increase as viscosity increases. For many applications, pressure drop through an LCE meter is on the order of 0,21 bar (3 PSI) for metering liquids with approximate viscosity of 30 SSU (1 cP).

For additional pressure loss data, consult the factory.

## Meter flow rate limit (percent of rated flow vs. viscosity)

Use the chart below to determine maximum meter flow rate relative to meter bearings material and product viscosity: (1) determine the percent of rated capacity at which the meter will be required to operate; (2) determine product viscosity at system operating temperature; (3) plot the point on the chart where the two lines intersect; (4) determine the meter bearing material from construction/application table above.

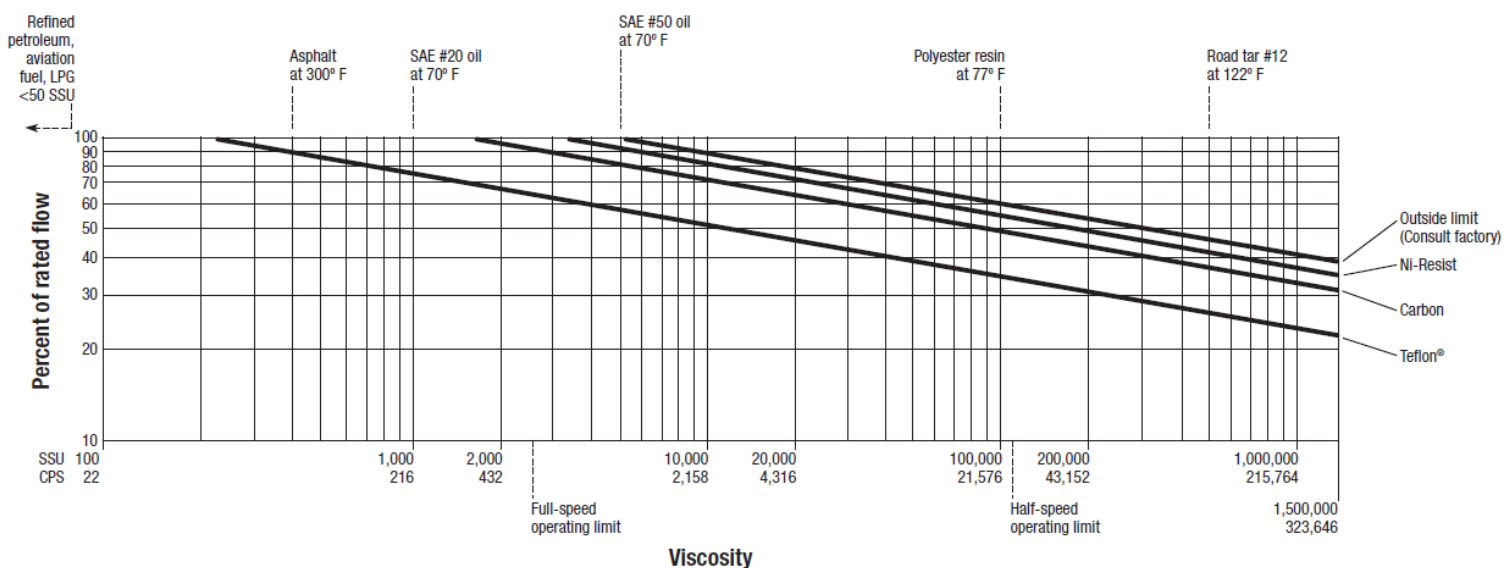

## Construction and application classes

LCE steel-case PD meters are suitable for metering a broad range of products as listed below. The appropriate meter class can be used to specify a desired meter by using the table on the next page of this publication.

Class	Description	Bearing Material
1	Refined petroleum products	Ni-Resist
2	Aviation and jet fuel	Ni-Resist
7	Chlorinated solvents	Carbon
8	Acid pH liquids includes: nitric, phosphoric, glacial acetic acids, citric juices, vinegar	Carbon
10	LPG	Carbon
14	Crude oil	Ni-Resist
16	General solvents	Carbon
37	Sodium Hydroxide solutions, high sulfur crude oil, alkaline pH liquids	Ni-Resist

## Purchase specifications

To make certain you receive a meter with the many installation, operating and maintenance advantages of a Liquid Controls product, please include the following statement in your engineering and purchase specifications.

"Meter shall be of the positive displacement design having rotary motion without axial thrust or flow impingement. No eccentric, sliding, reciprocating or oscillating parts to induce excess liquid shear or liquid compressibility within meter element. Rotary parts to be horizontally supported on both sides by solid support bearings and rotor journals of materials compatible with product to be metered. No ball bearings, springs or cams. Rotary drive and meter adjustment output to all readout devices shall be non-cyclic without pulsation and capable of meter accuracy adjustment of 0.02% or better. Meter calibration adjustment device must be externally accessible, not requiring removal of any readout equipment for calibration or replacement. Meter measuring element shall have a minimum braking torque and shall immediately respond to product low flow movement."

## Ordering information (please refer to chart at right for LC model naming system)

Model: \_\_\_\_\_ - \_\_\_\_\_ - \_\_\_\_\_ - \_\_\_\_\_ Description: \_\_\_\_\_

Flow rates: Max. \_\_\_\_\_ Normal \_\_\_\_\_ Min. \_\_\_\_\_

Operating temperatures: Max. \_\_\_\_\_ Normal \_\_\_\_\_ Min. \_\_\_\_\_

Maximum non-shock operating pressure: \_\_\_\_\_

Maximum viscosity: \_\_\_\_\_ @ \_\_\_\_\_ (Temp°/F or C)

Specific gravity: \_\_\_\_\_

Construction class: (1, 2, etc.) \_\_\_\_\_ Seal material:  Standard Buna/Viton  All Viton  All Teflon

Direction of flow:  L to R  R to L Read out:  Gallons  Liters  Pounds  Other \_\_\_\_\_

Mechanical counter and printer:  Zero/Face up  Zero/Face down  Accumulative

Strainer basket:  40M  80M  100M  Other \_\_\_\_\_

Flange size: \_\_\_\_\_ Flange type:  RF or FF ANSI  DIN  Other \_\_\_\_\_

Options: \_\_\_\_\_

\_\_\_\_\_

\_\_\_\_\_

## Product model numbering system:

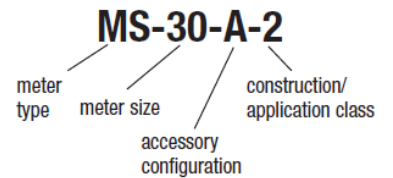

## Standard accessory configurations (A, C, I, K): MS-30 meter shown

MS/MSA-30-**A**

A=Meter with counter

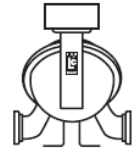

MS/MSA-30-**C**

C=Meter with counter, strainer and air eliminator

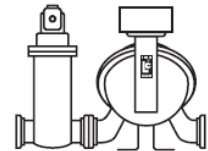

MS/MSA-30-**I**

I=Meter with counter, preset counter and preset valve

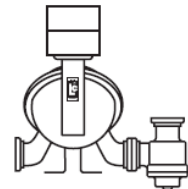

MS/MSA-30-**K**

K=Meter with counter, preset counter, preset valve, strainer and air eliminator

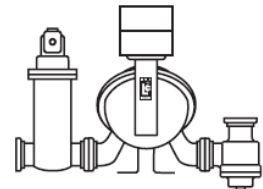

## LIQUID CONTROLS EUROPE

Manufactured by **SAMPI**

A Unit of **IDEX Corporation**

S.A.M.P.I. spa - Via Amerigo Vespucci, 1

55011 Altopascio (Lucca) - ITALY

Phone: +39 0583 24751

Fax: +39 0583 264748

